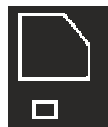
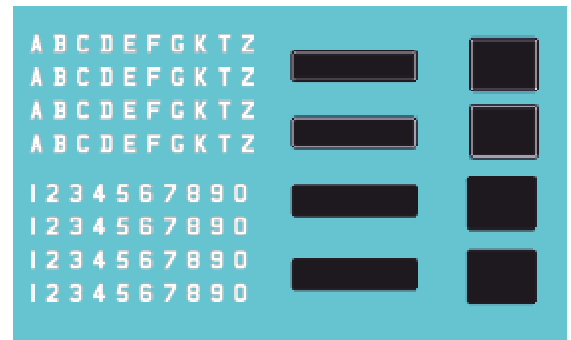

PHOTO-ETCHED PARTS



FILM



DECALS

RESIN PARTS



PHOTO-ETCHED PARTS



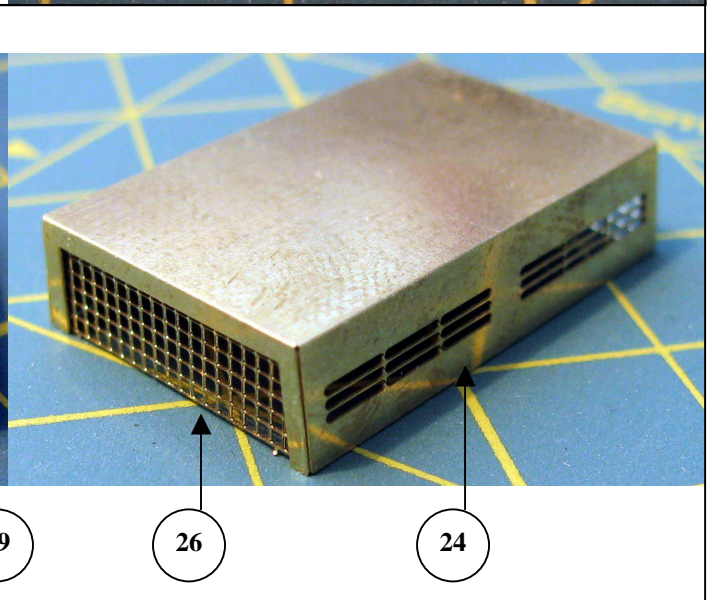
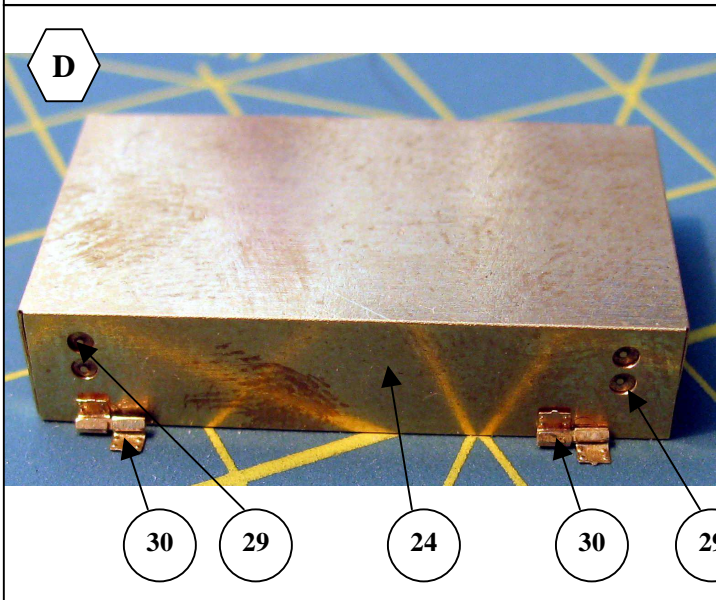
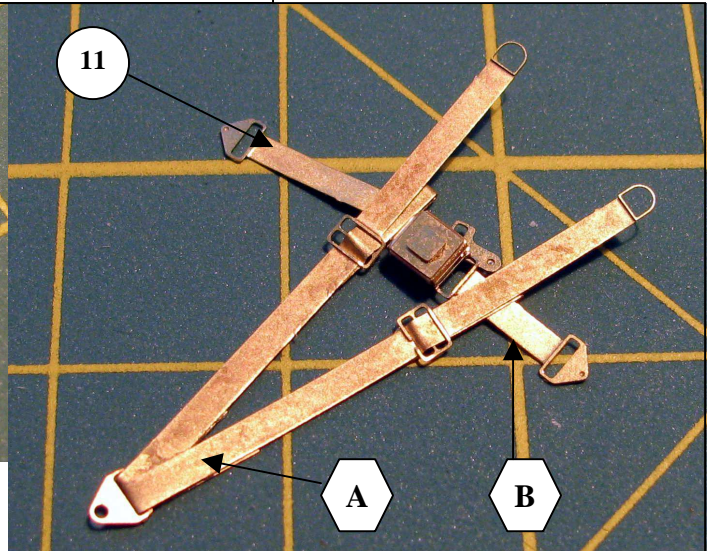
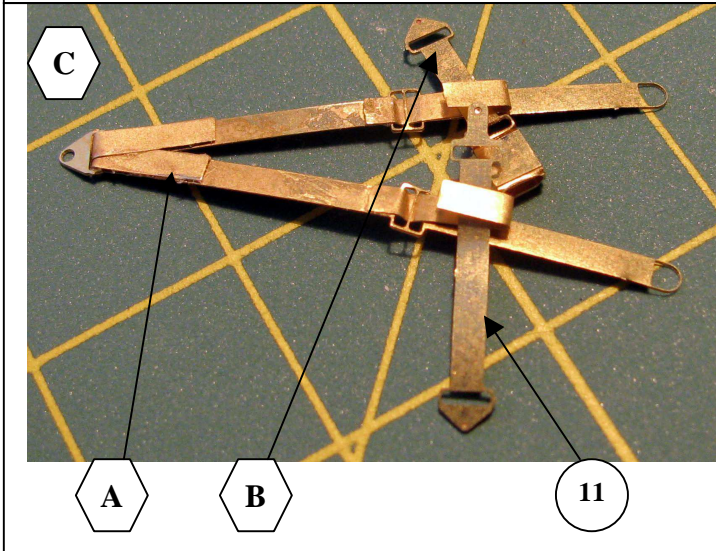
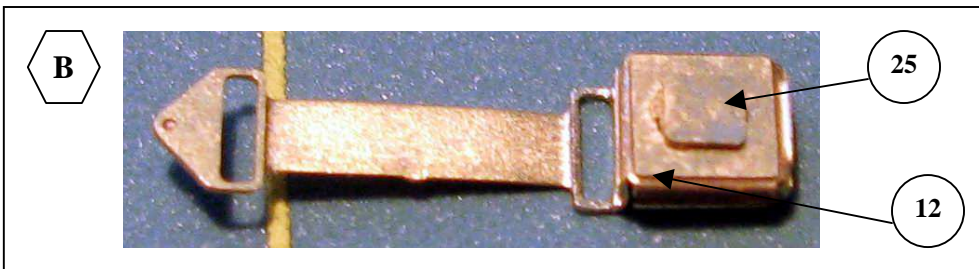
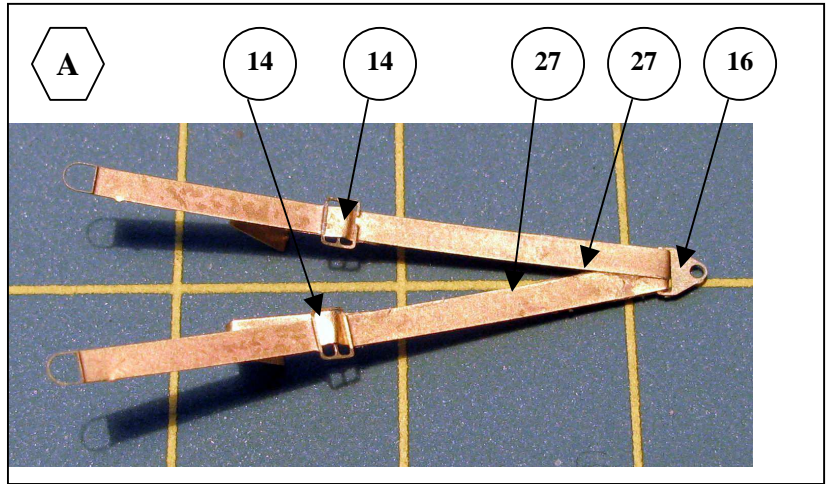

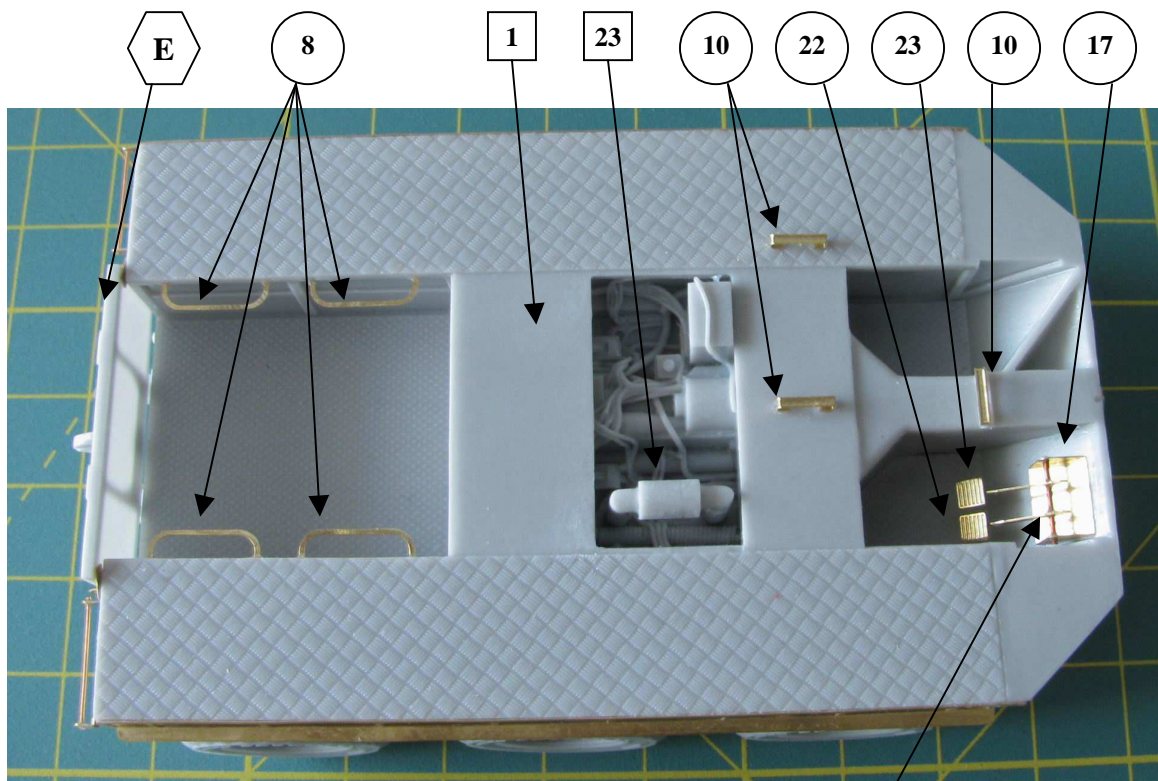
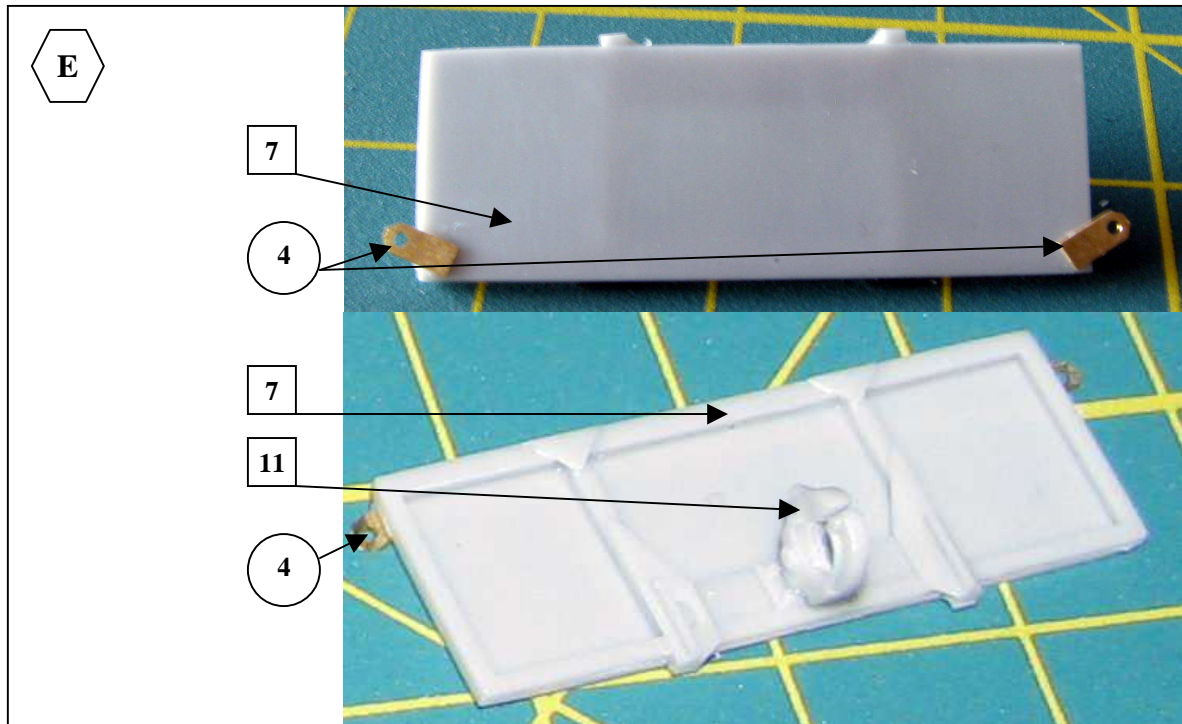

WIRE $\varnothing 0,5 - 8mm$

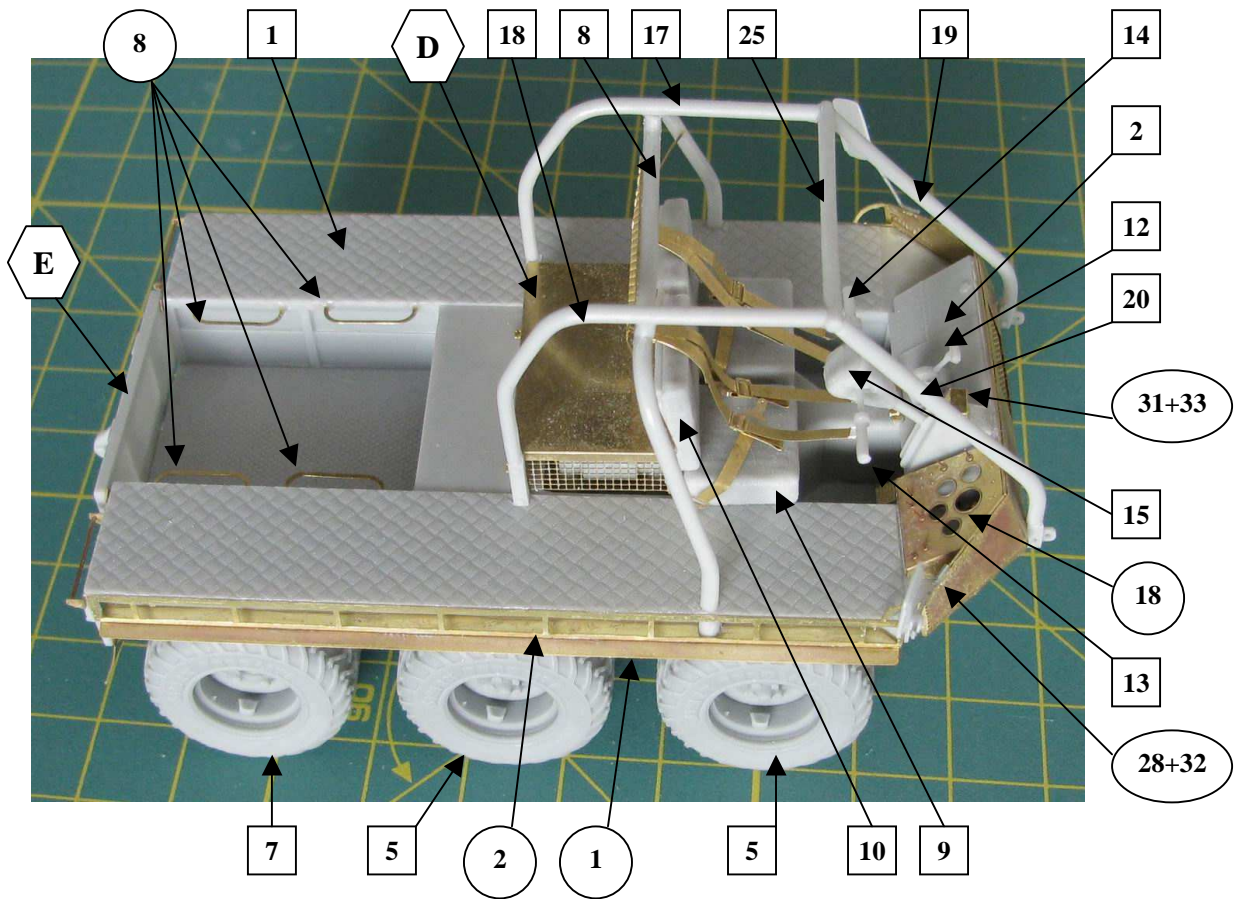
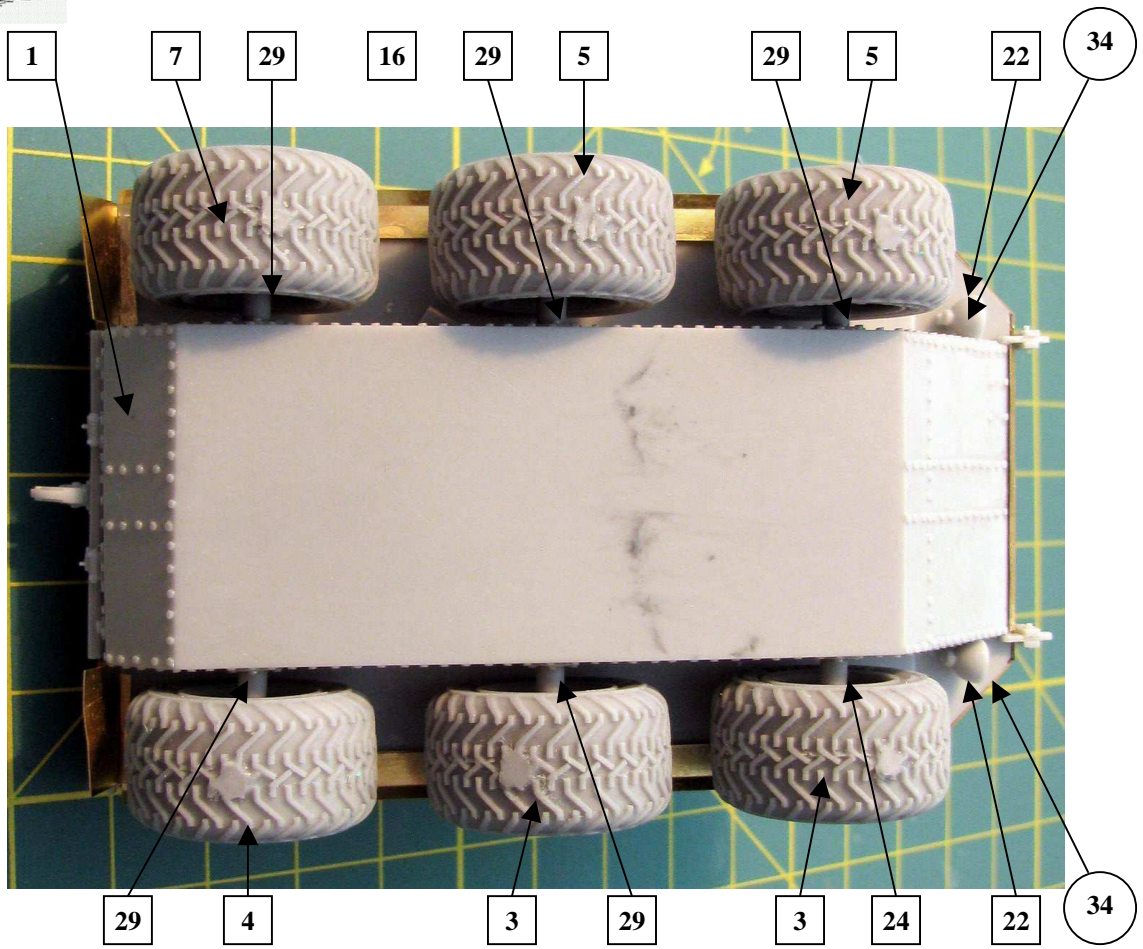

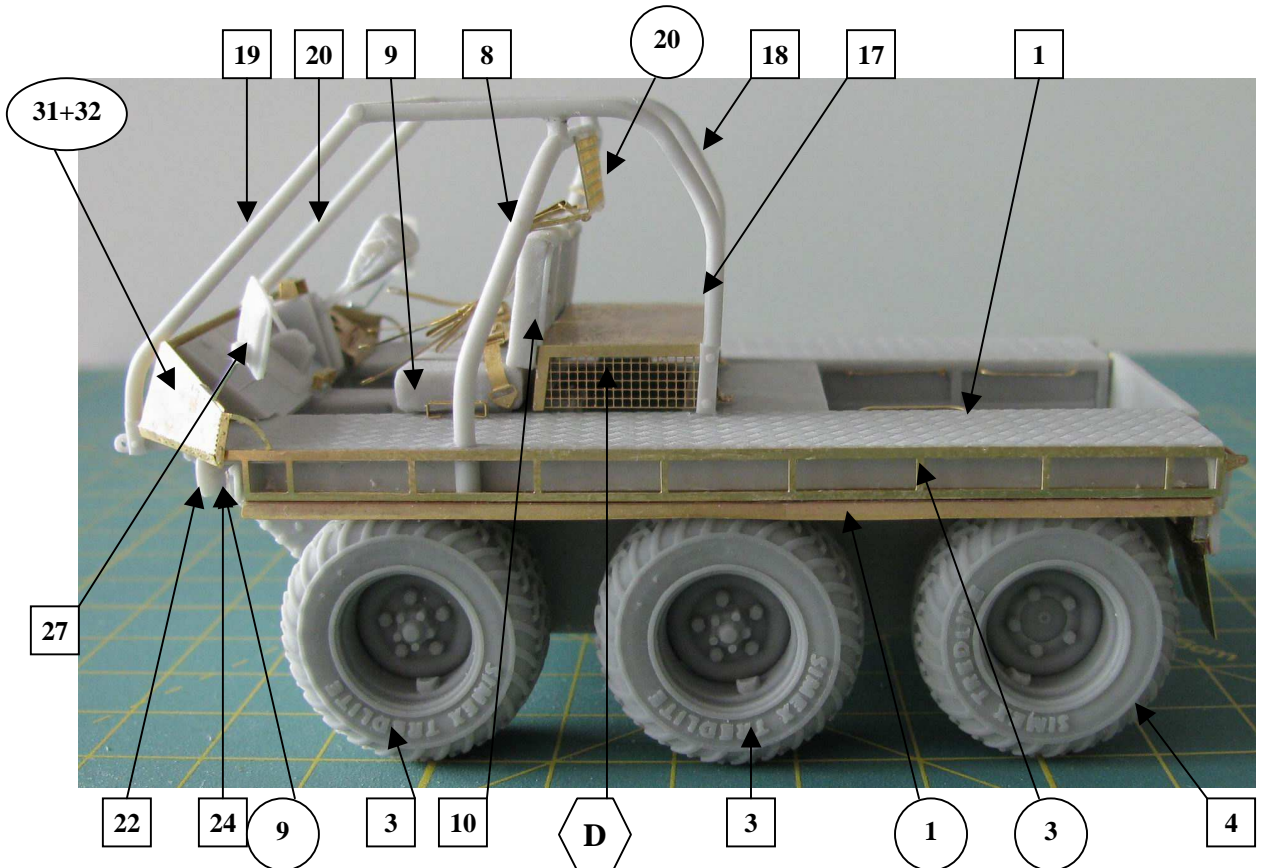
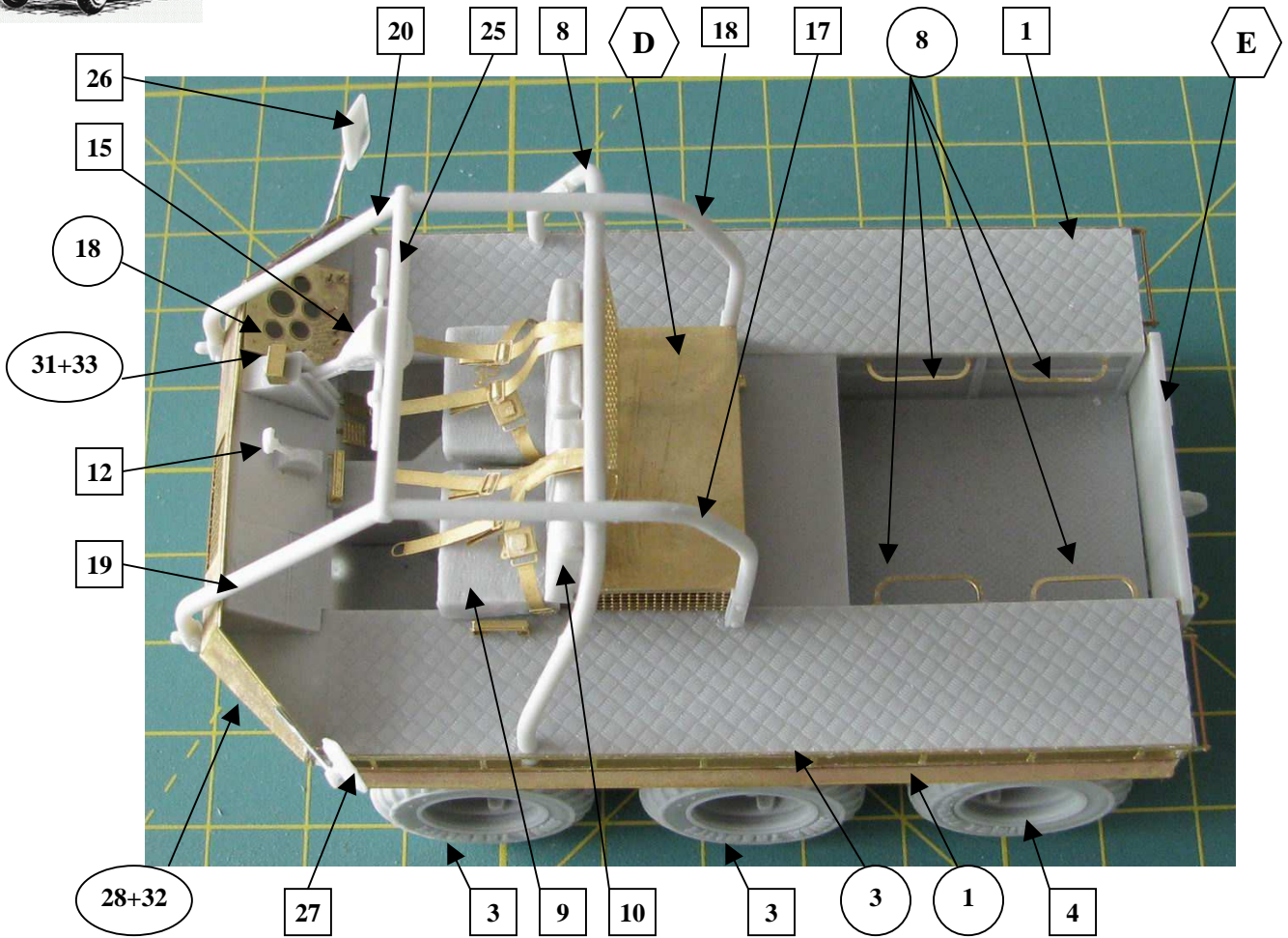

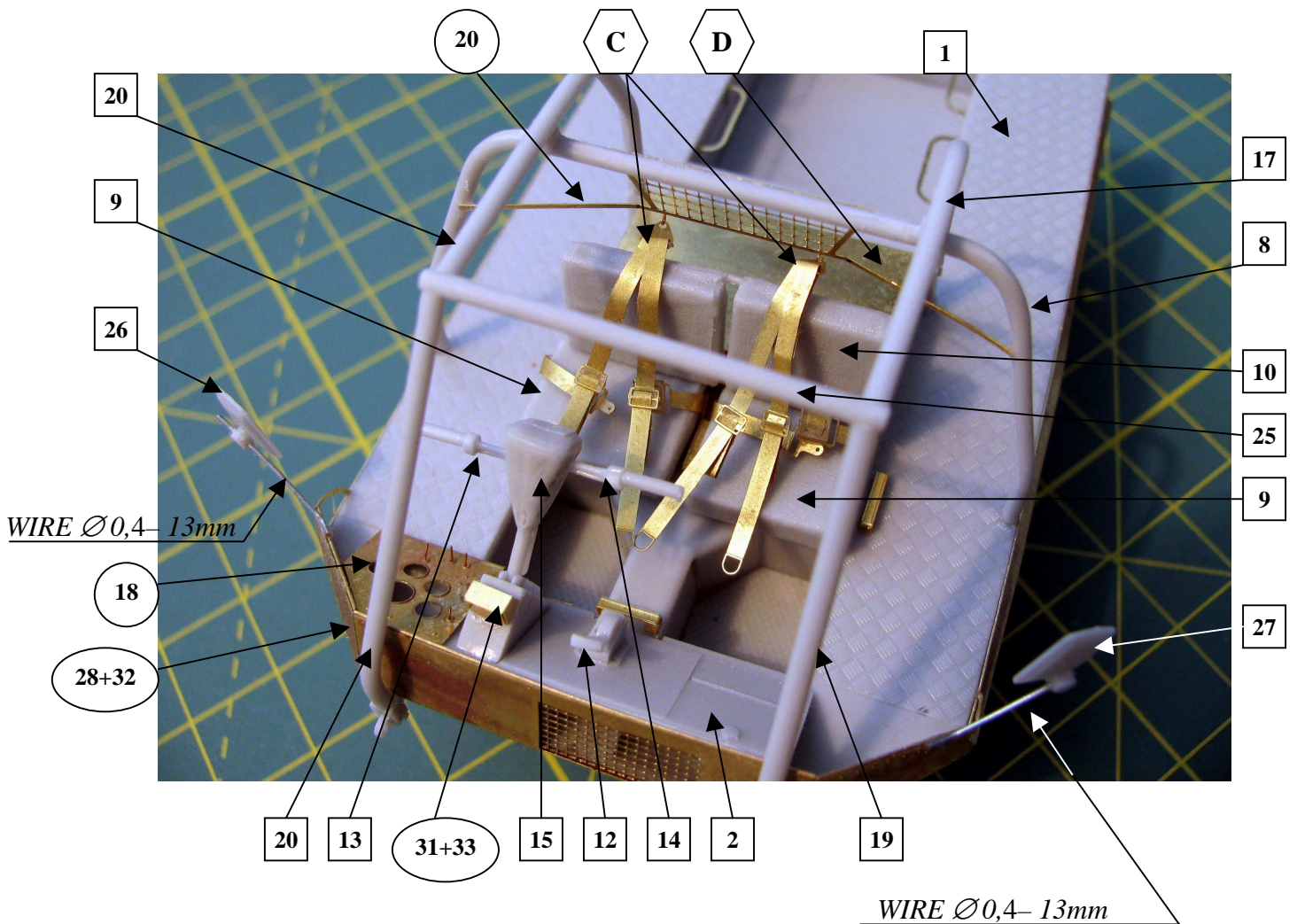
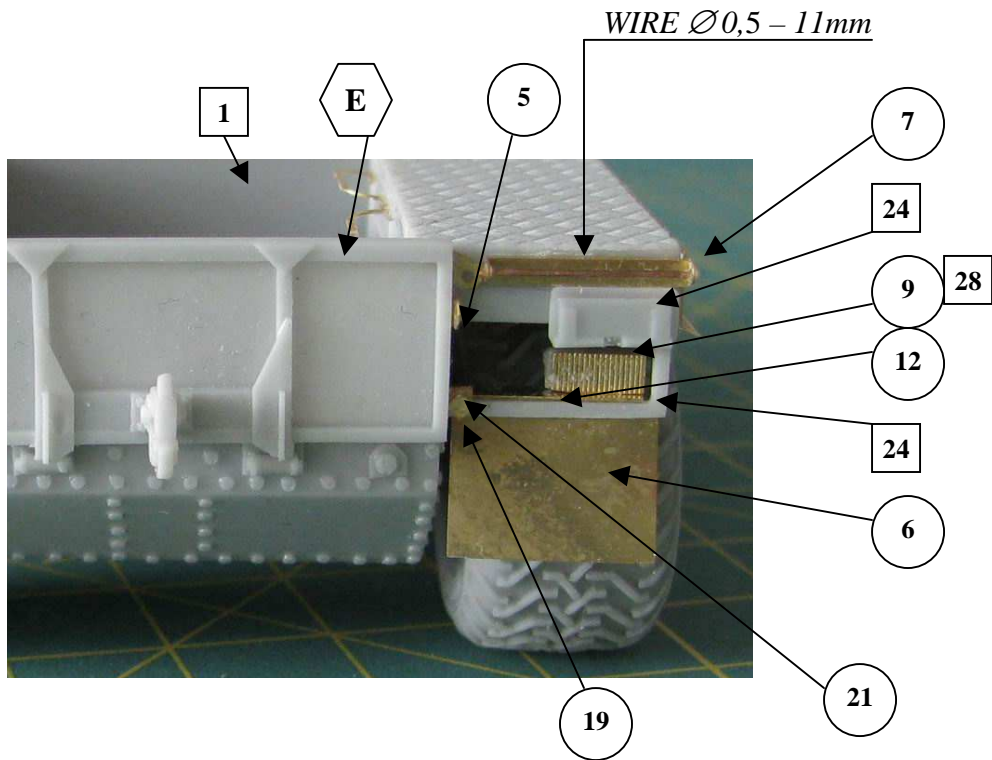



Supacat ATMP Mk3

1/35

F3054

7/7

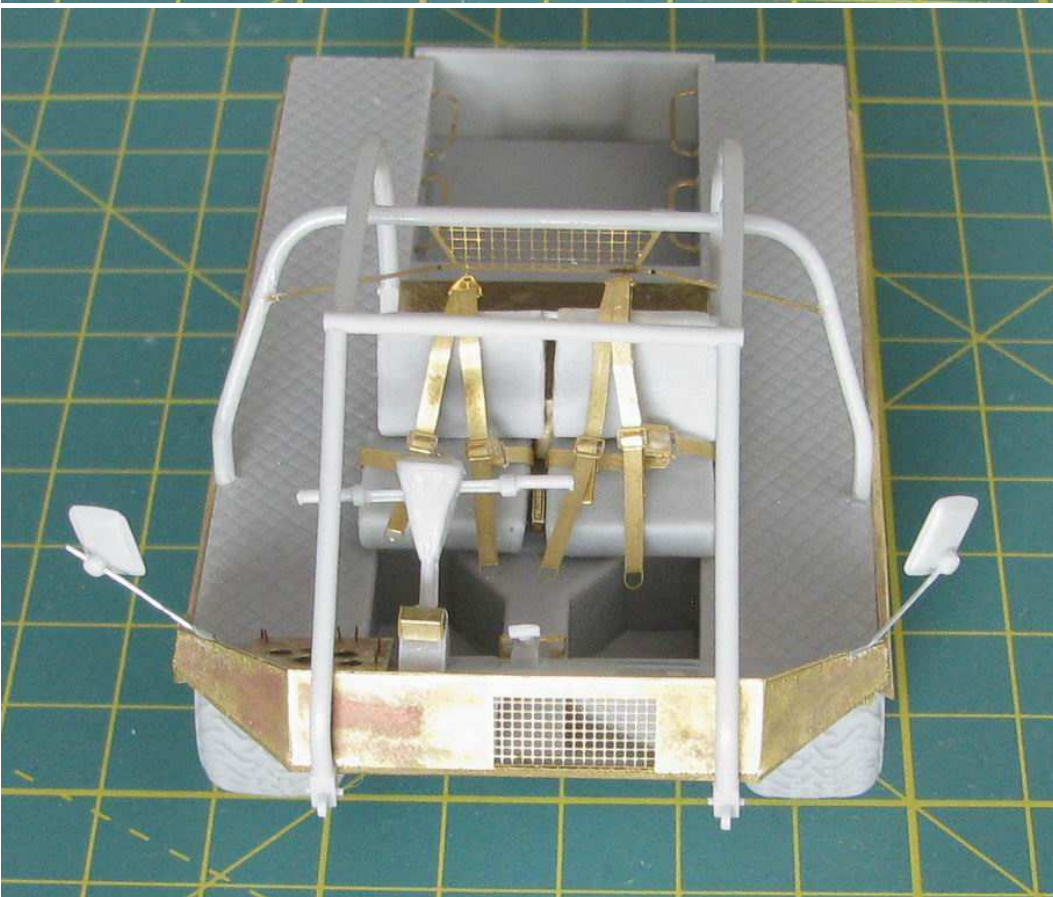
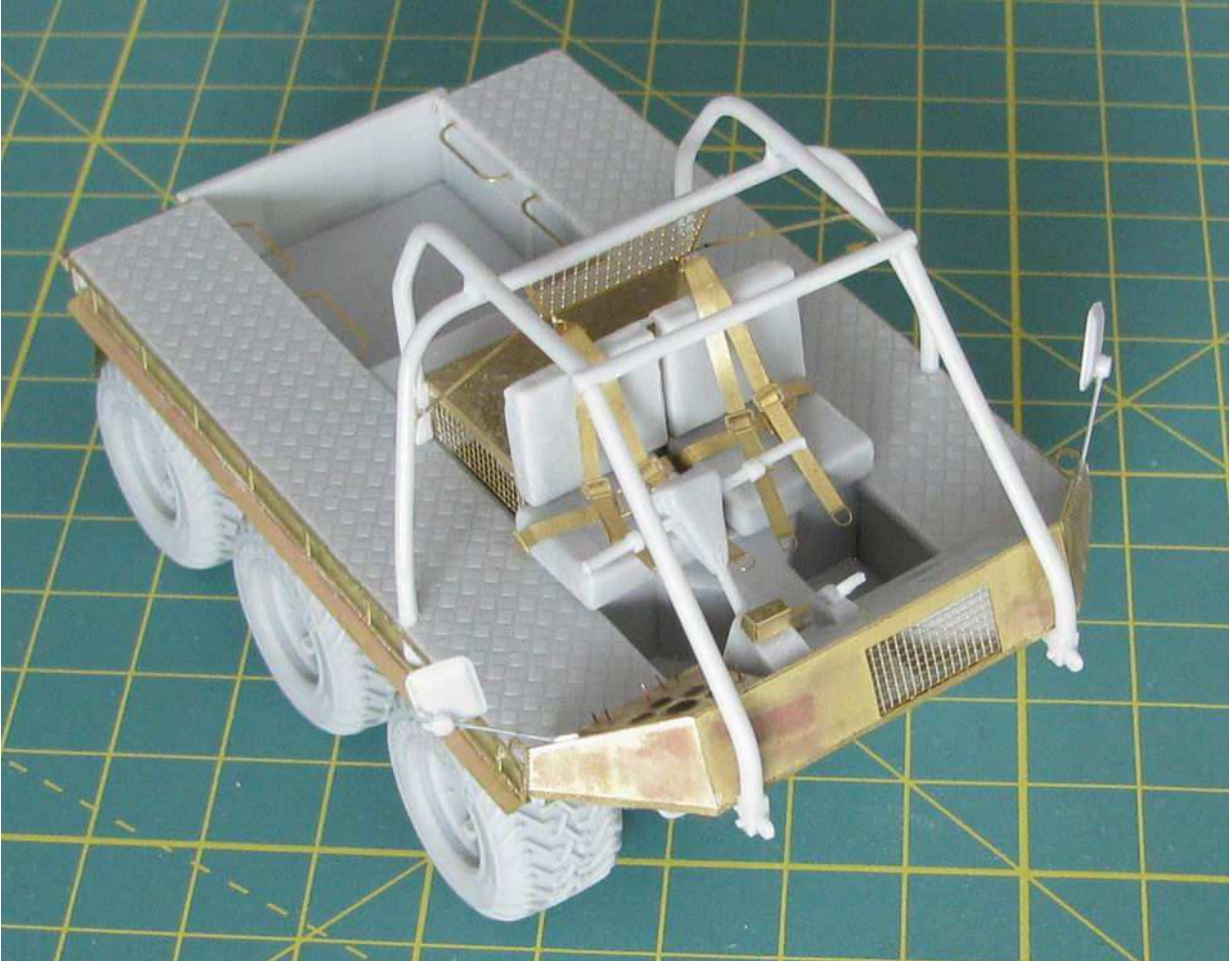



SLLPT

1/35

F3062

1/12

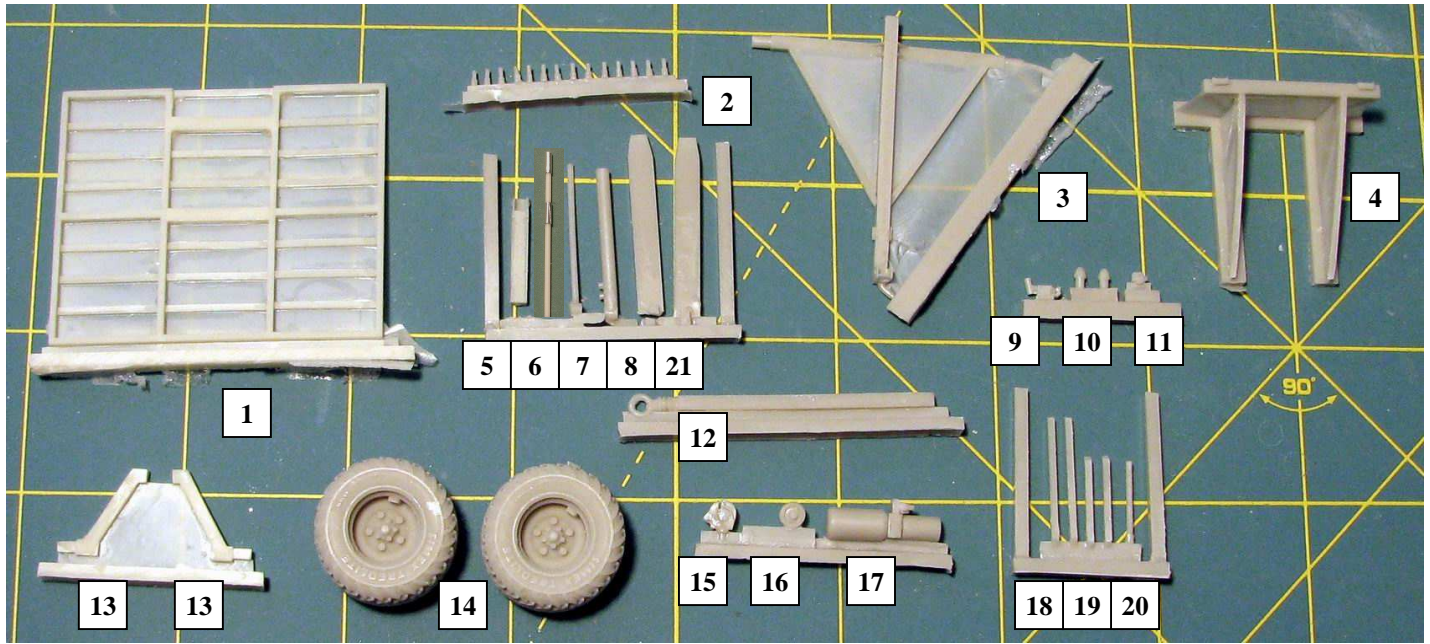

RESIN PARTS

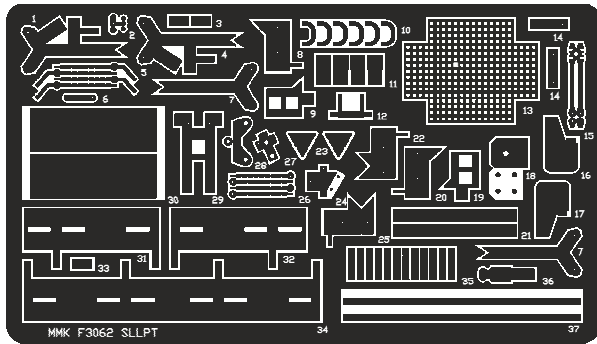

PHOTO-ETCHED PARTS

RESIN PARTS

xx

PHOTO-ETCHED PARTS

xx

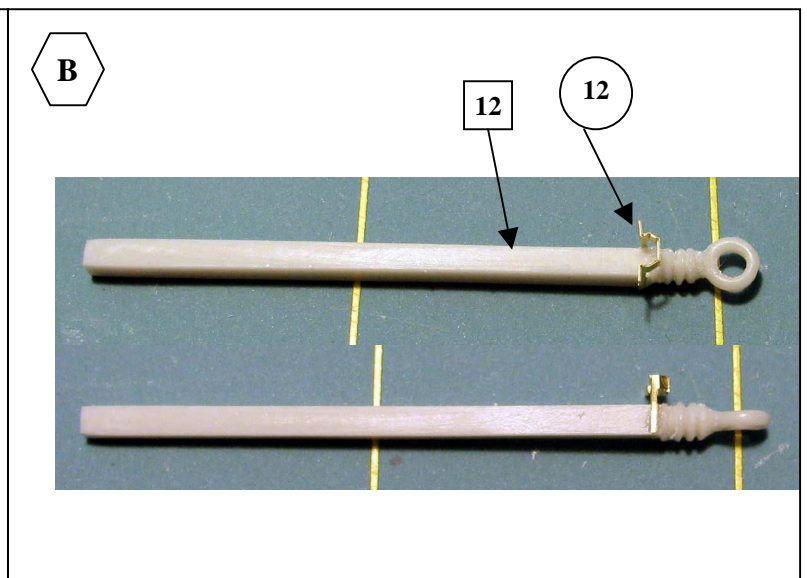
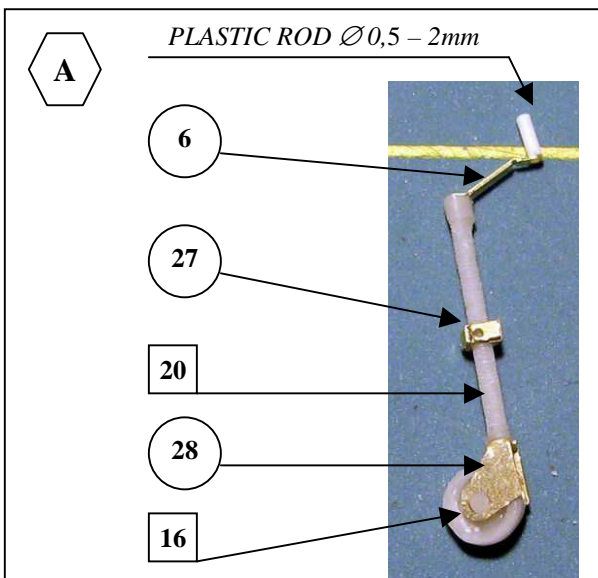



C

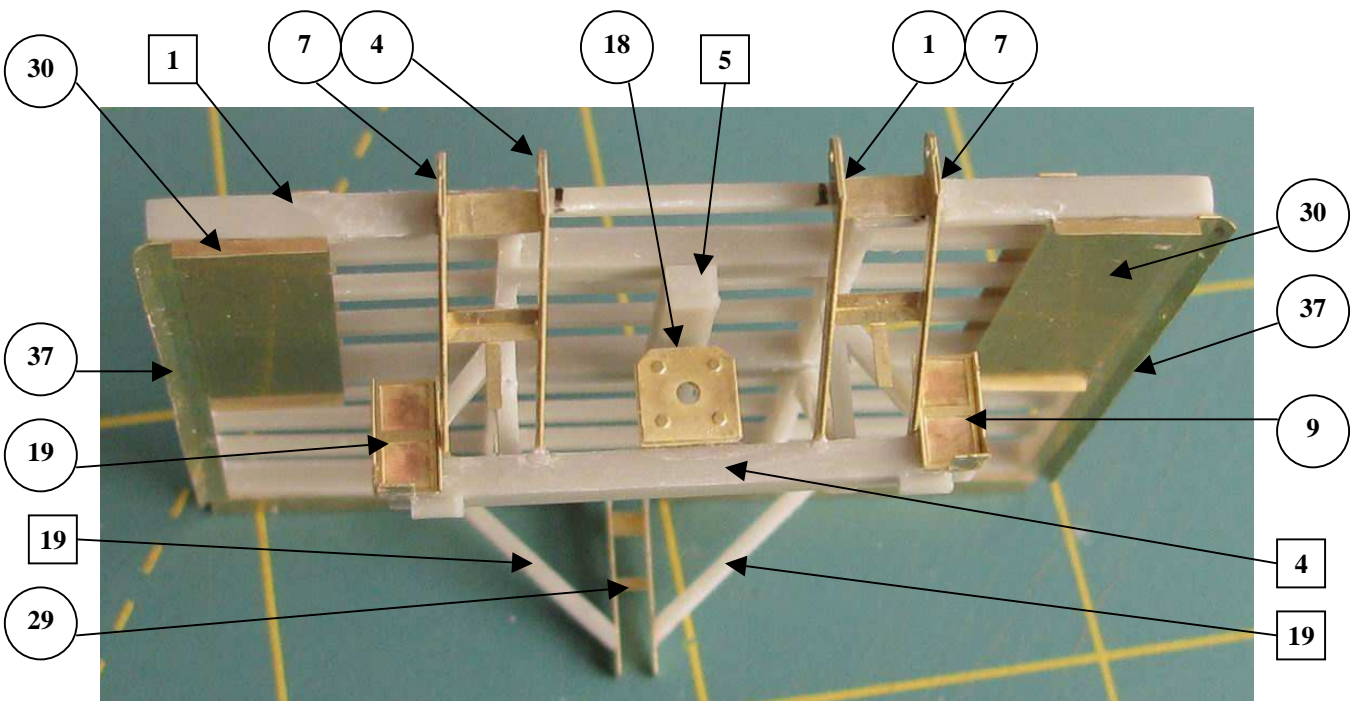
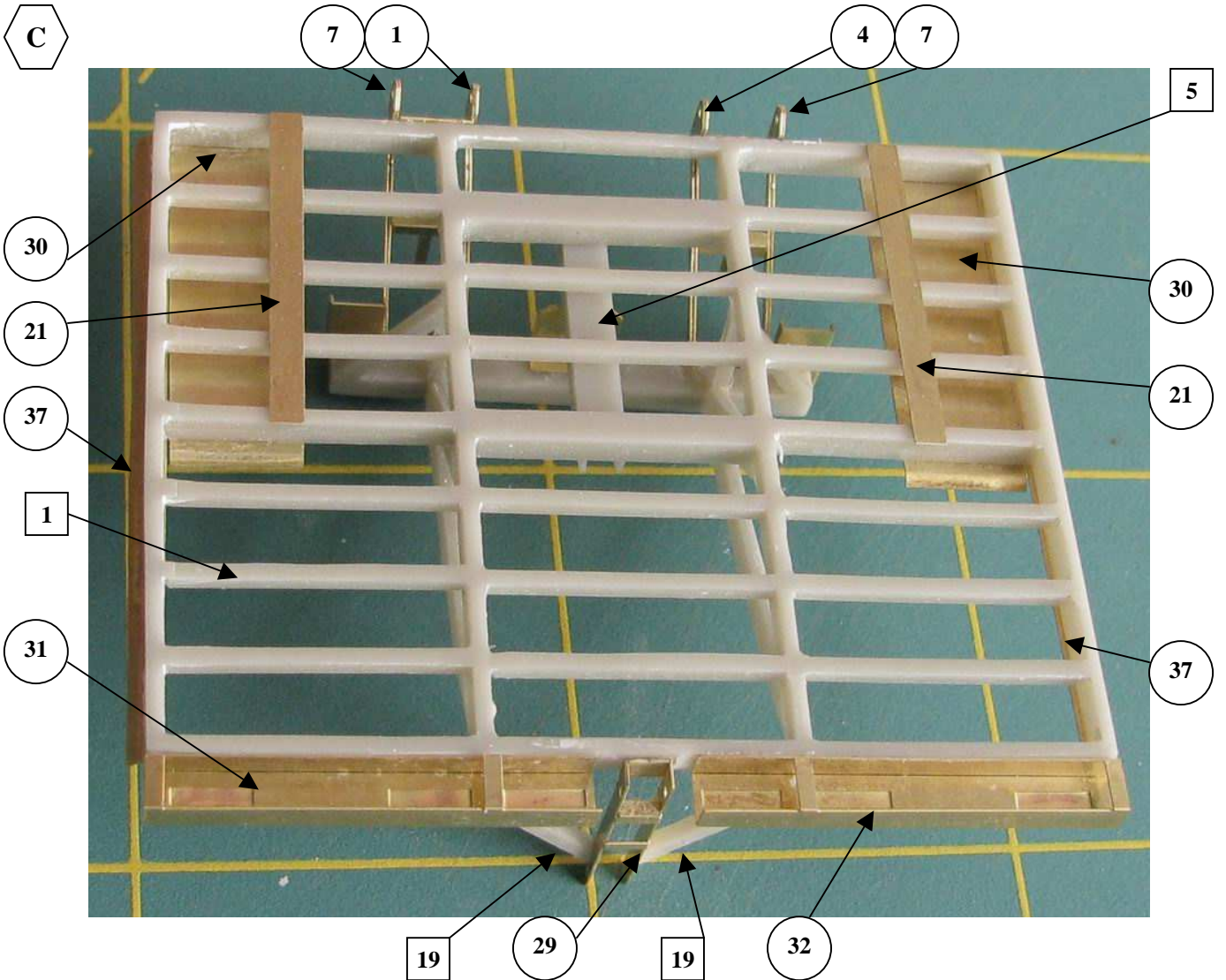



C

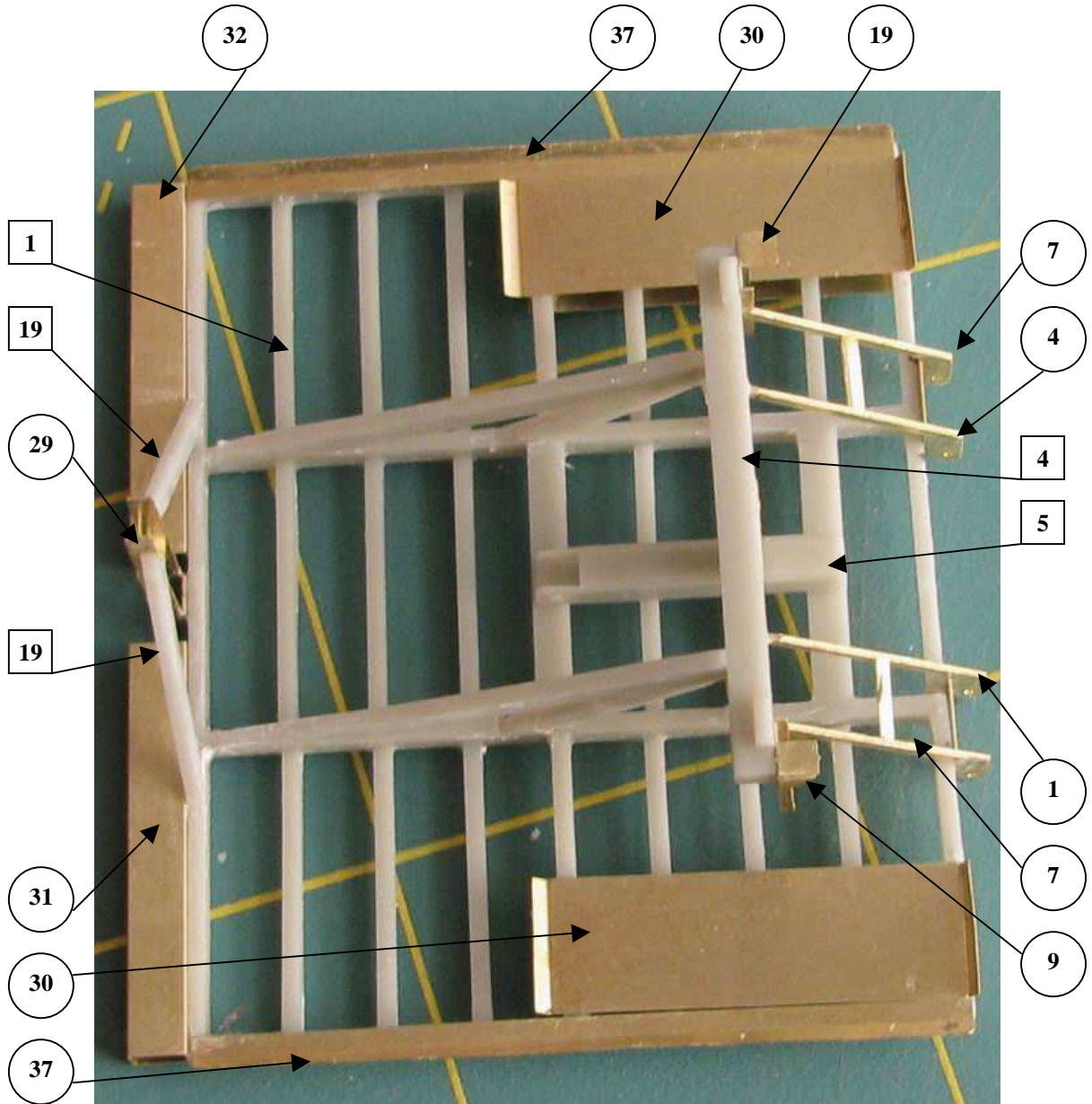

D

13

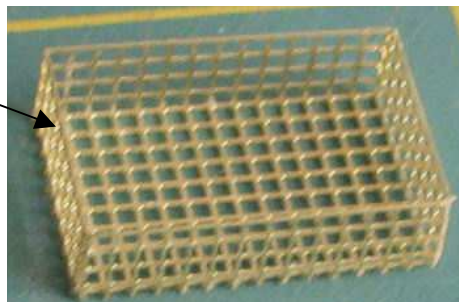

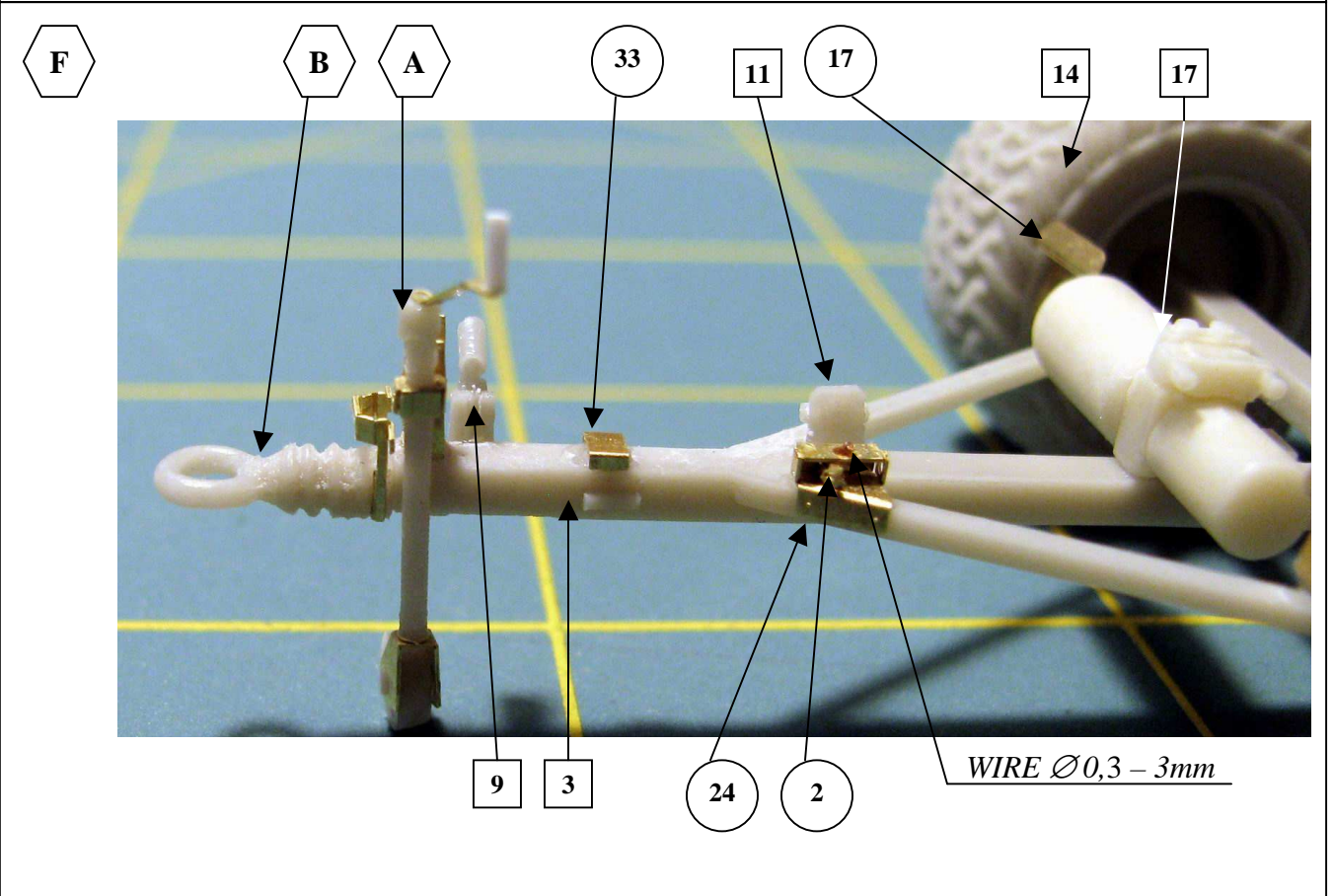
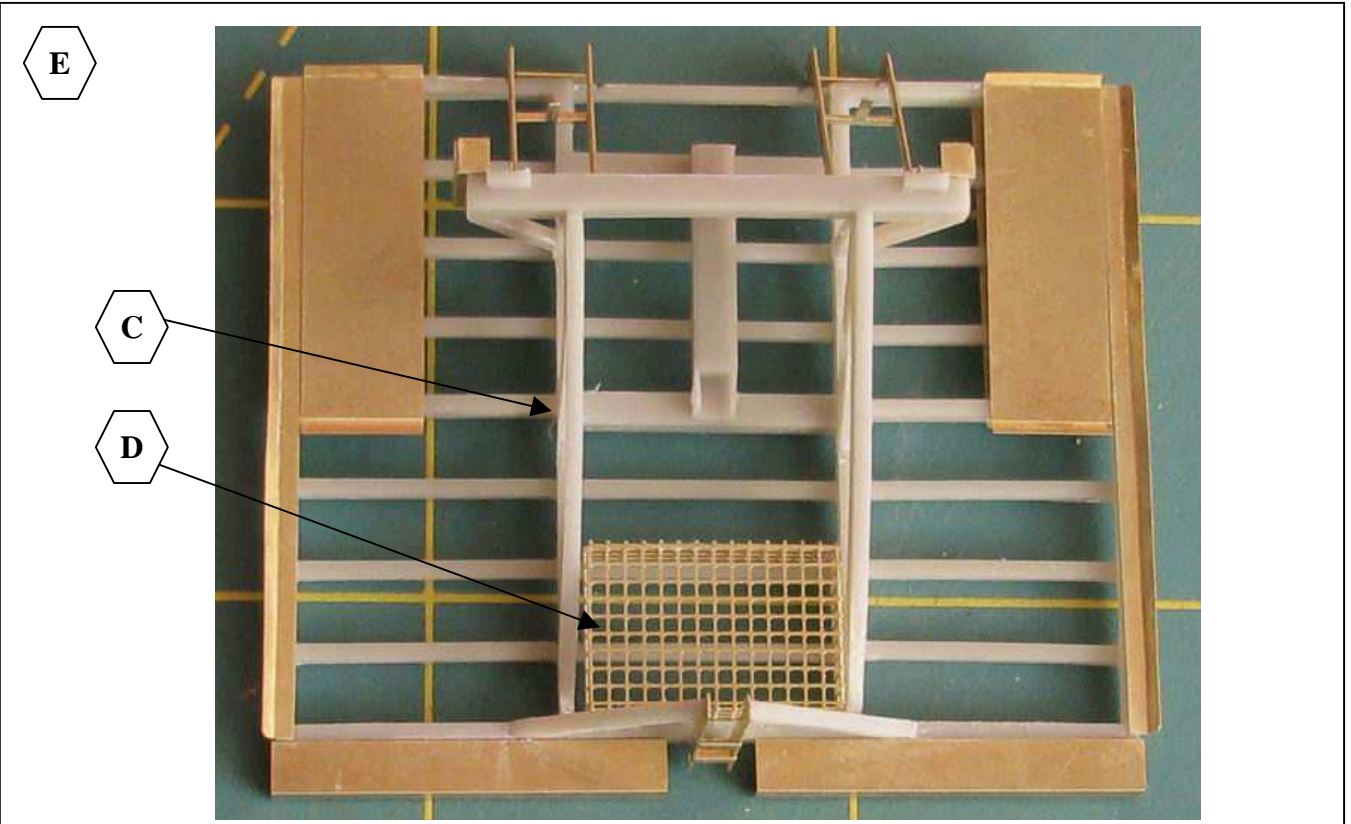



F

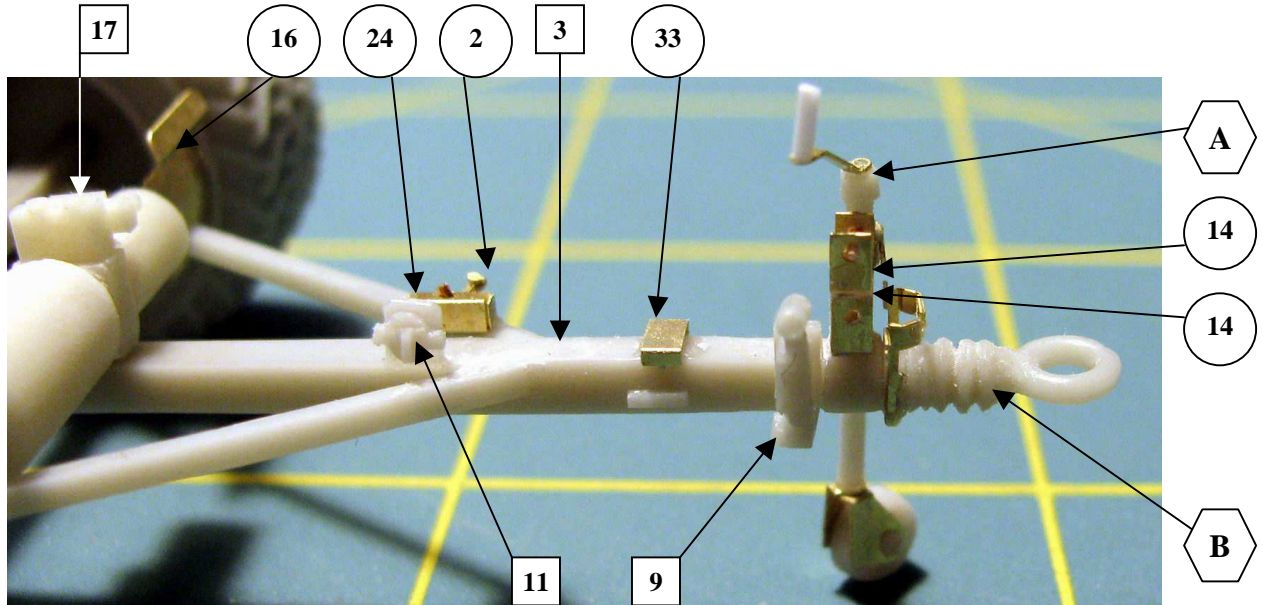
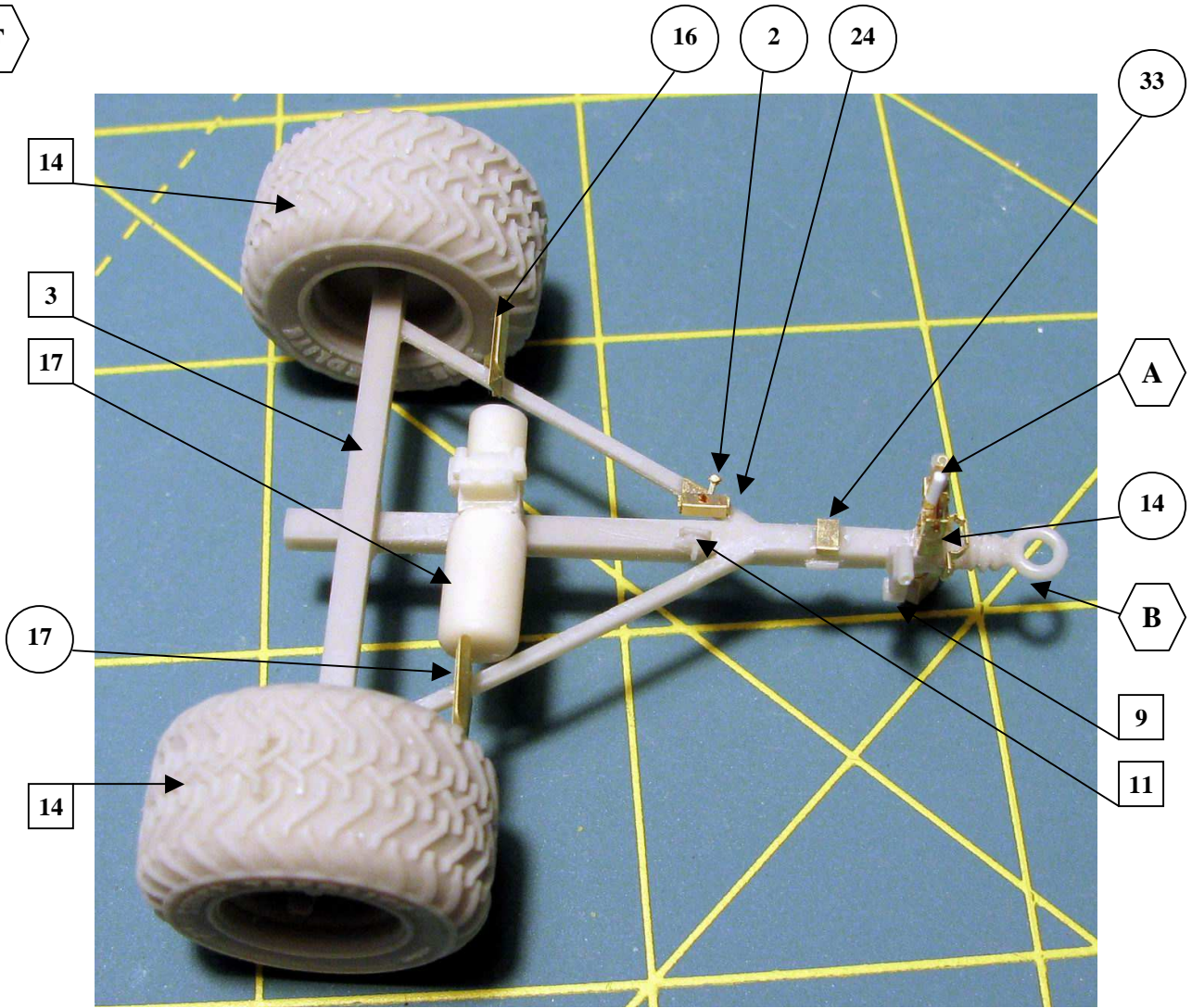



G

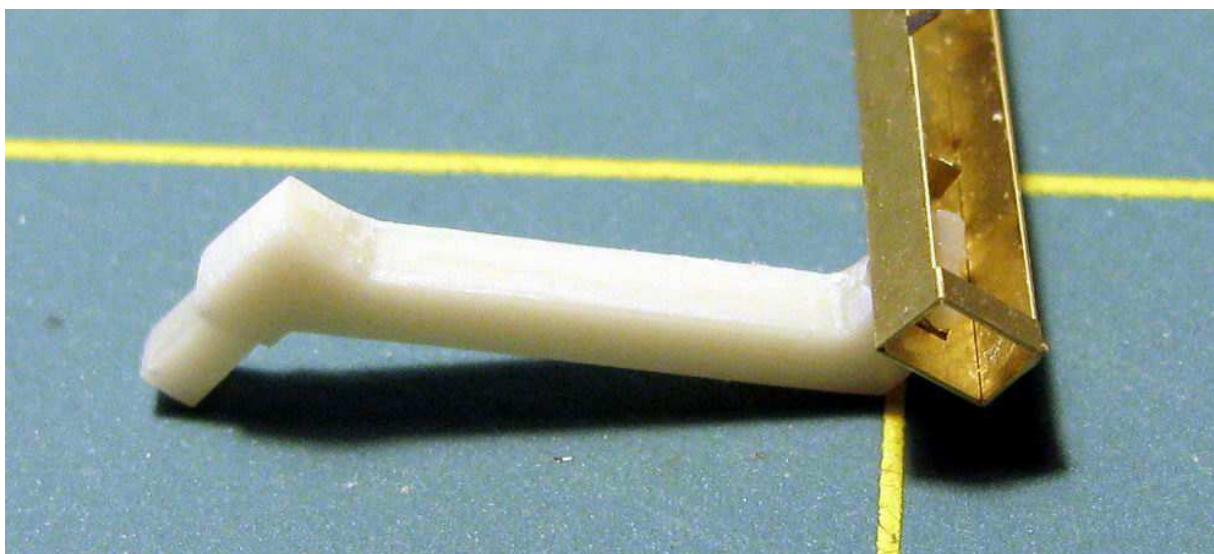
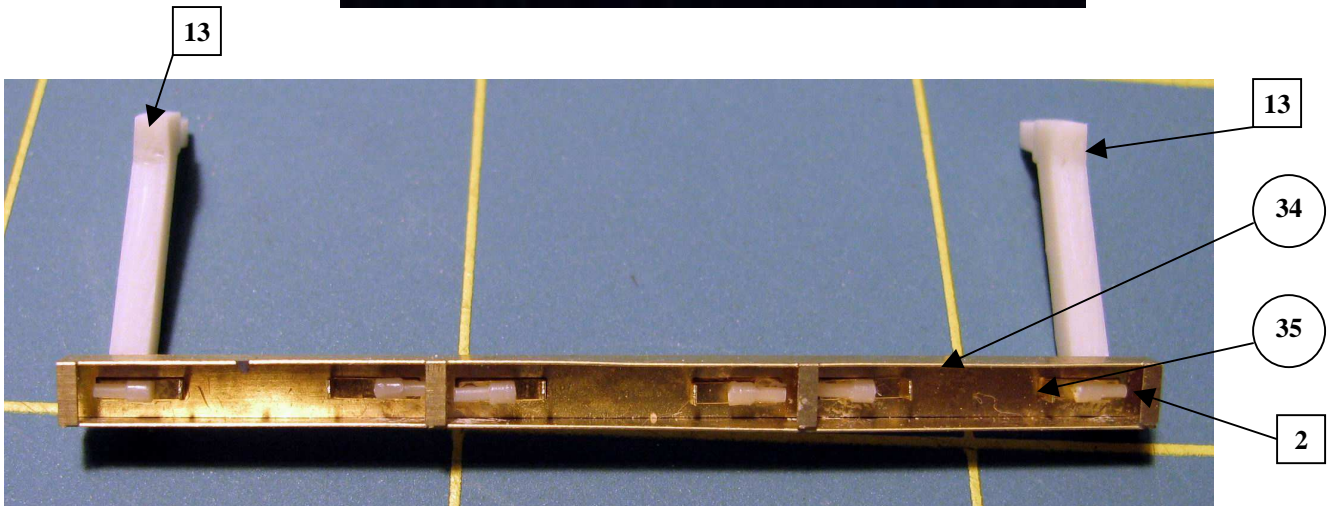
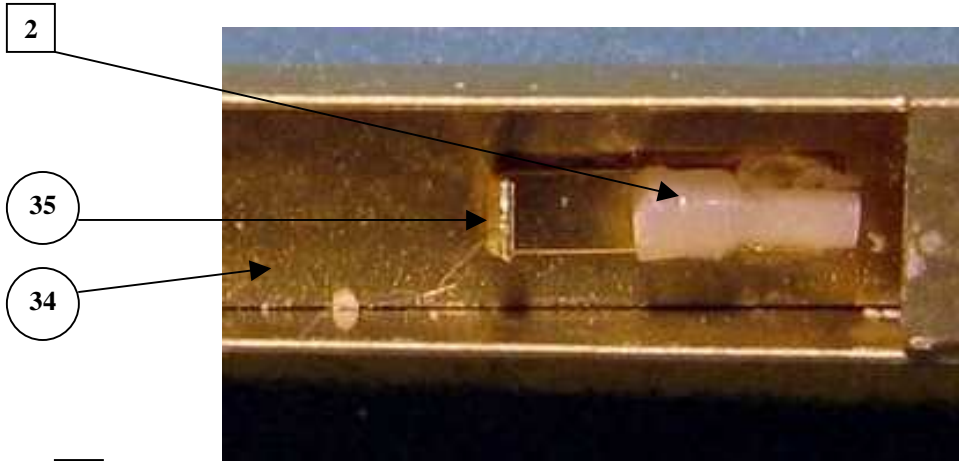



H

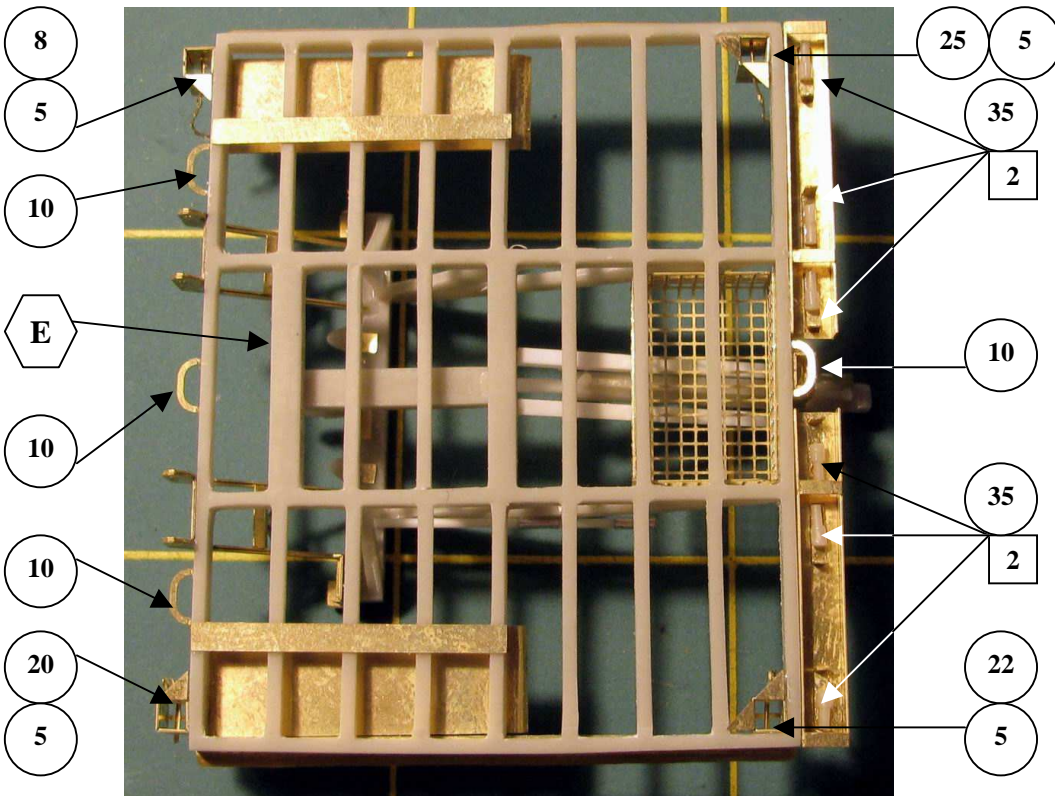
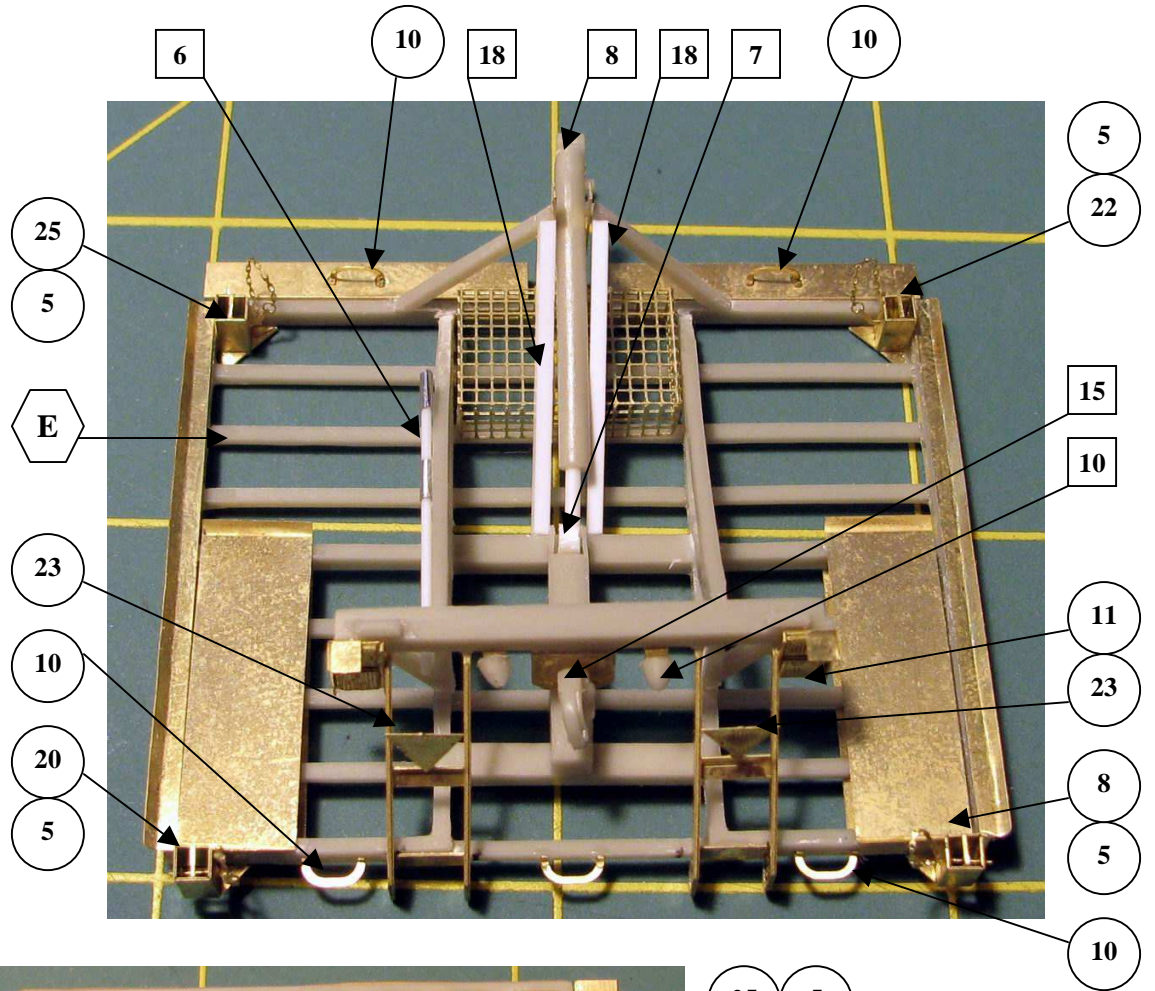



SLLPT

1/35

F3062

8/12

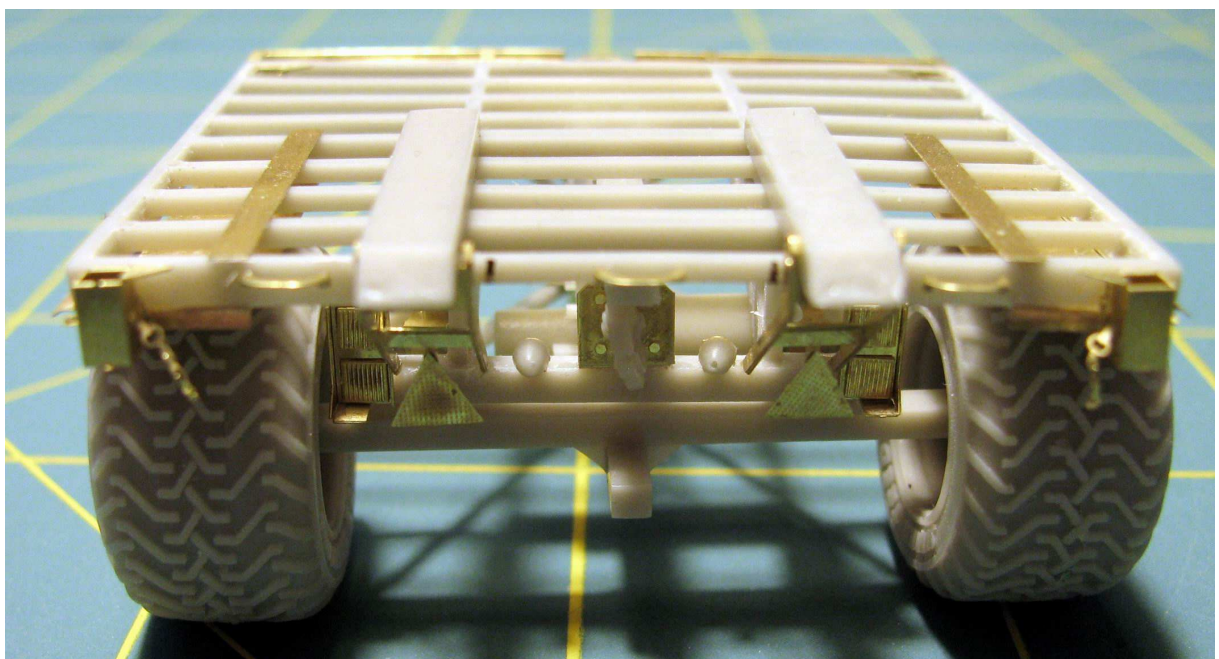
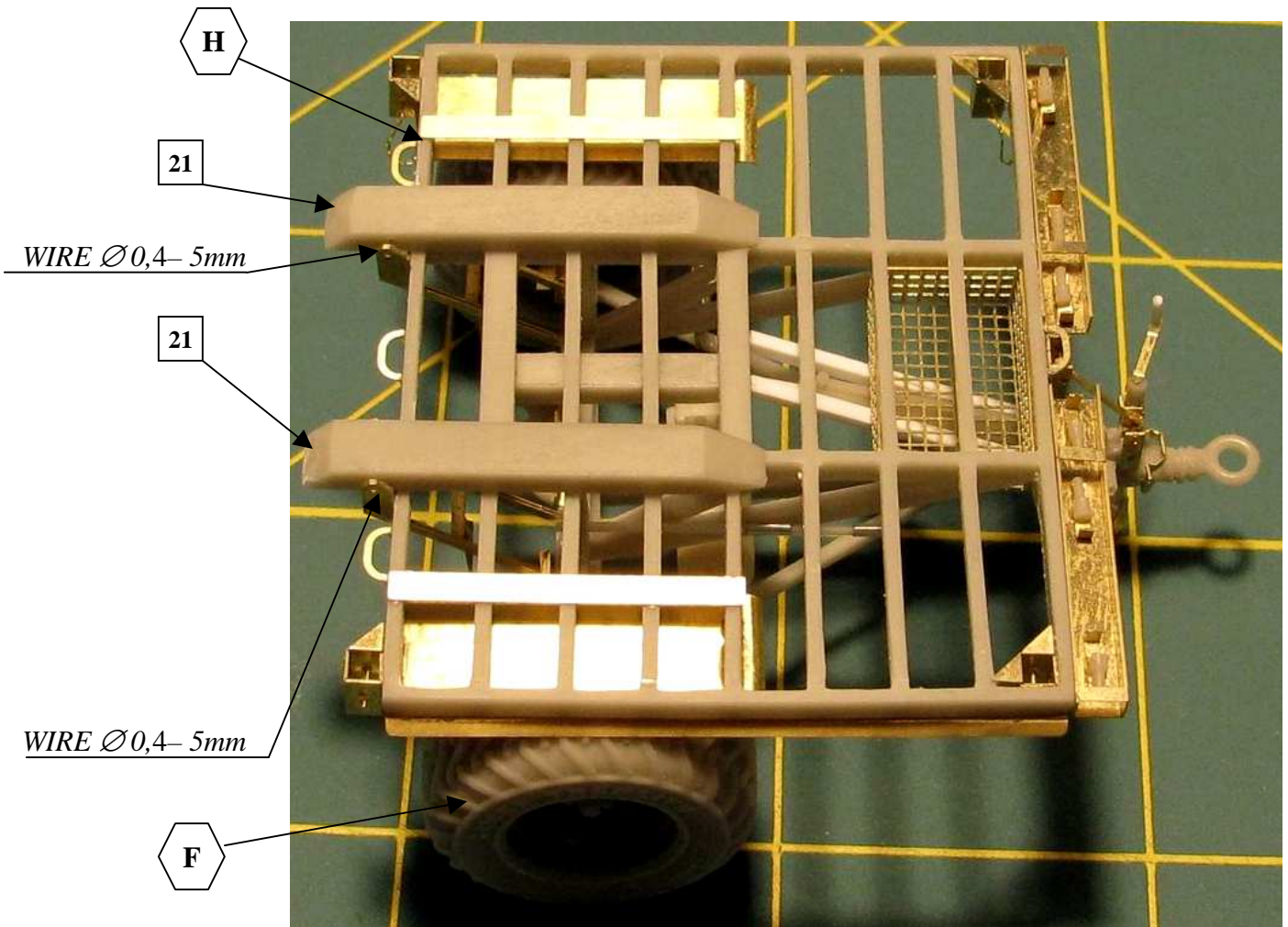



SLLPT

1/35

F3062

9/12

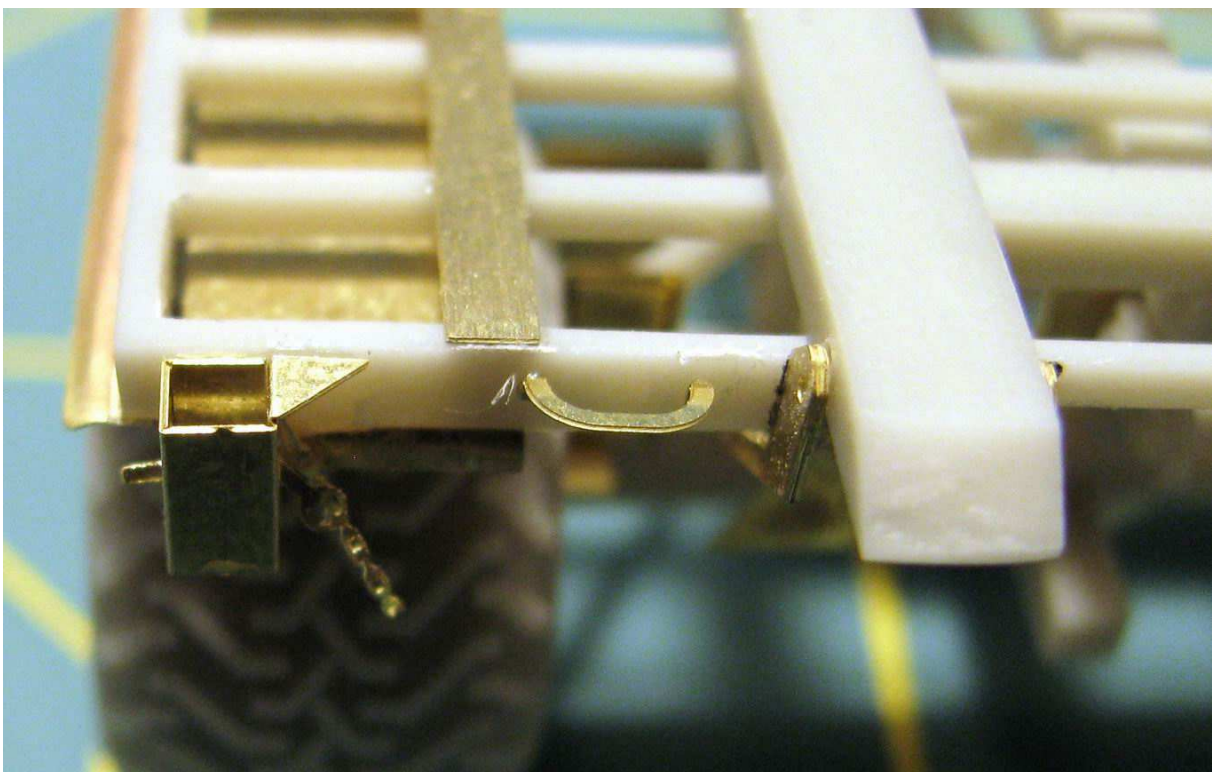
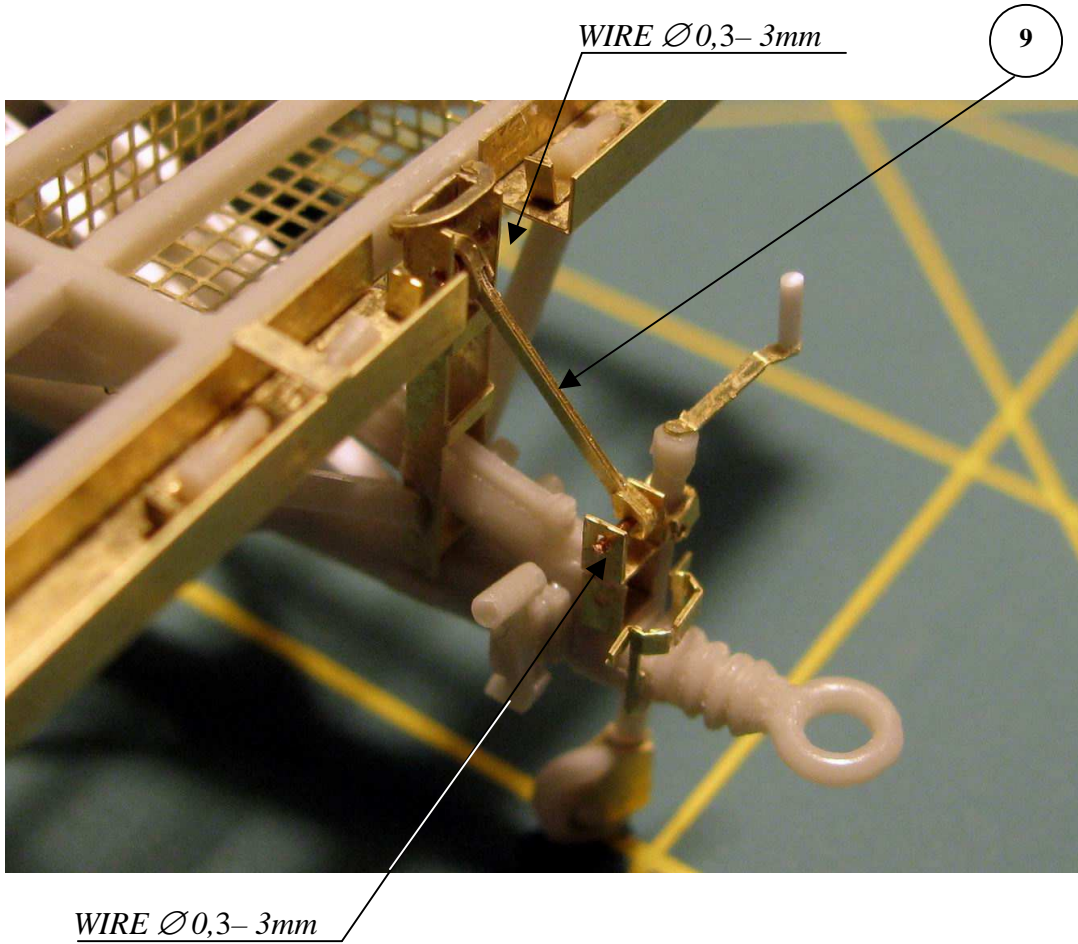



SLIPT

1/35

F3062

10/12

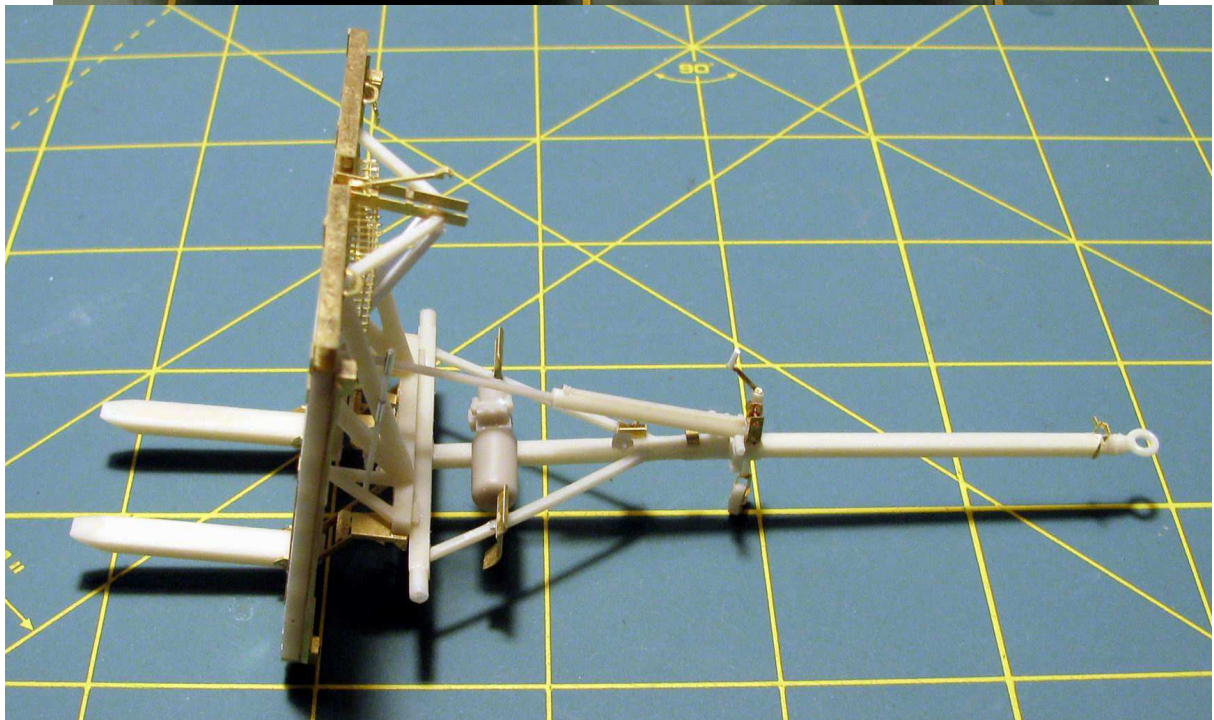
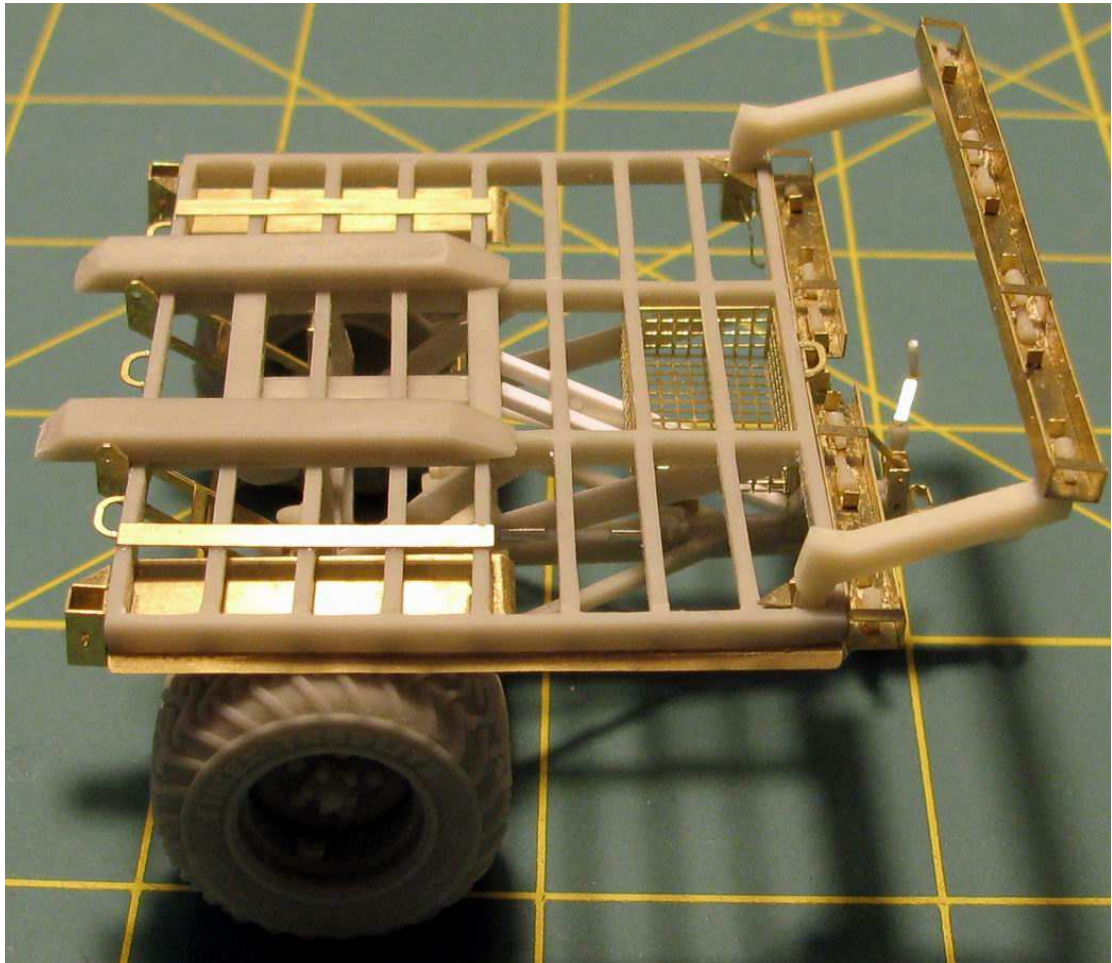



SLLPT

1/35

F3062

11/12





SLLPT

1/35

F3062

12/12

